

ENERGIZER NO. L91

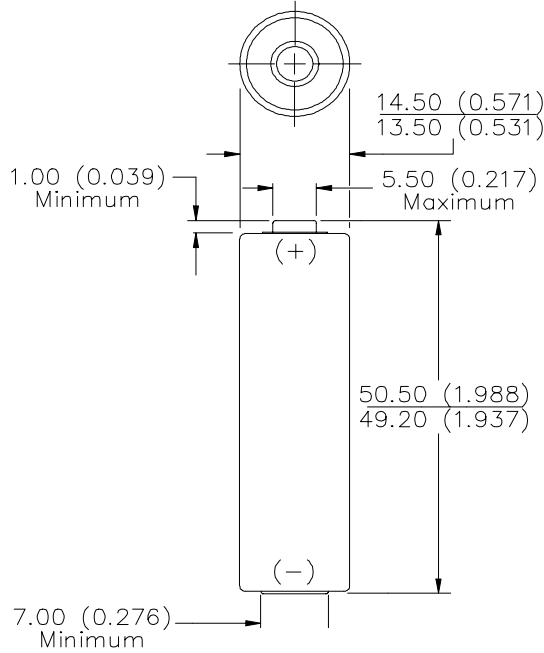

Chemical System: Lithium
Lithium/Iron Disulfide (Li/FeS₂)

Designation: ANSI-15LF, IEC-FR6

Battery Voltage: 1.5 Volts

Average Weight: 14.5 grams (0.5 oz.)

Volume: 8.0 cubic centimeters (0.5 cubic inch)

Storage Temp: -40°C to 60°C (-40°F to 140°F)

Operating Temp: -40°C to 60°C (-40°F to 140°F)

Average Capacity: 3000 mAh (to 1.0 volts)
(Rated capacity at 200 mA drain.)

Max Discharge: 2 Amps Continuous
3 Amps Pulse (2 seconds max)

Lithium Content: Less than 1 gram (0.04 oz.) per cell

Jacket: Non-magnetic Plastic Label

Transportation: Meets requirements of 49CFR 173.185 (b)

CONSTANT CURRENT DISCHARGE
Typical Service

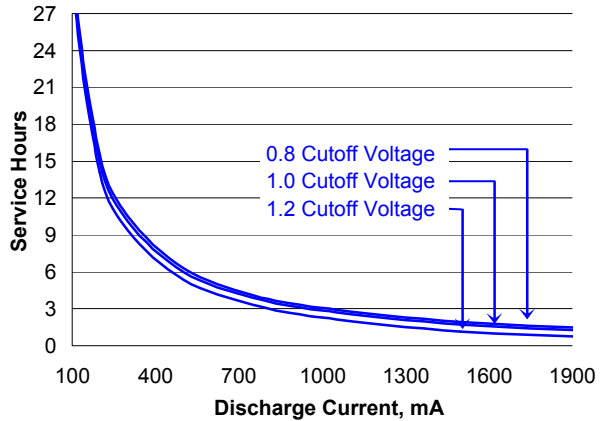

CONSTANT POWER DISCHARGE
Continuous @ 20°C to 0.9 volts

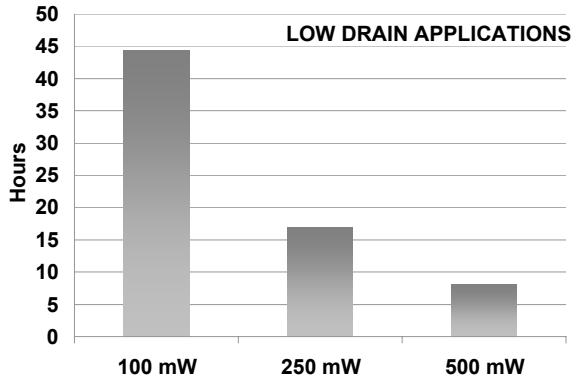

CONSTANT POWER DISCHARGE
Continuous @ 20°C to 1.0 volts

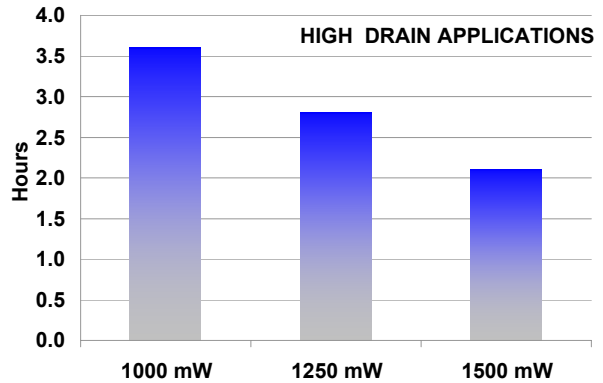

ENERGIZER NO. L91

Temperature Effects

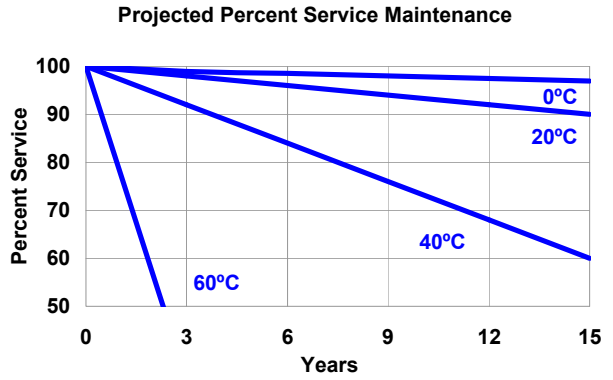
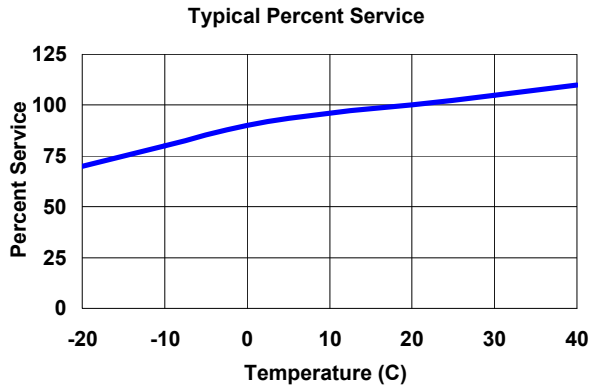

Industry Standard Tests @ 20° C

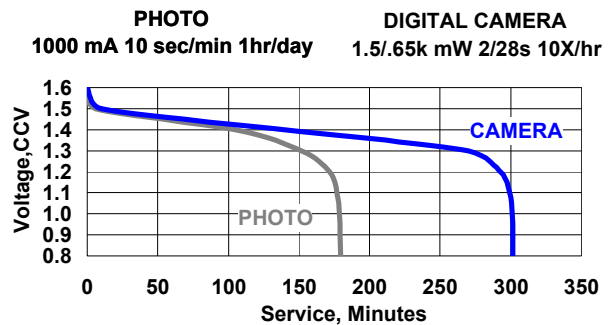
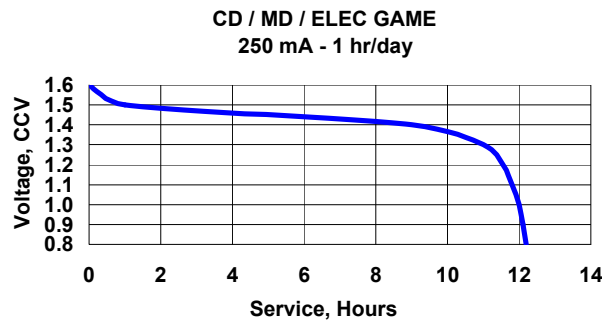
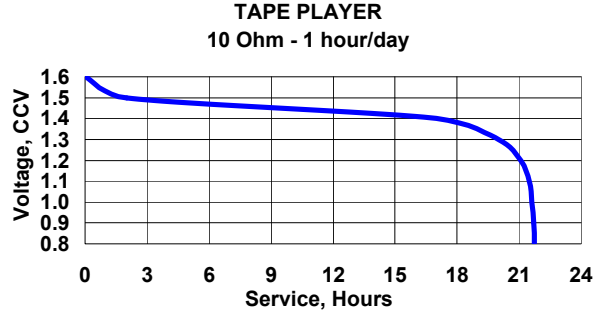
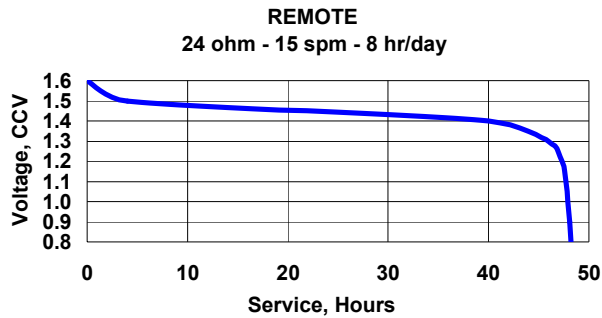
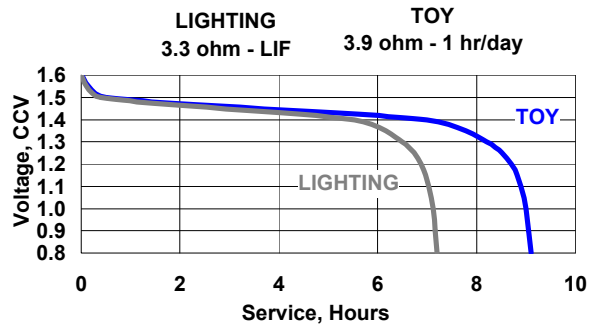
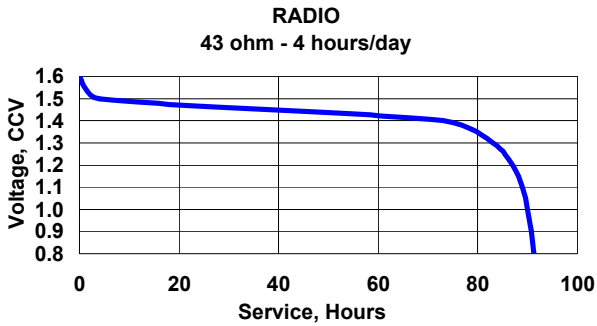

Important Notice

This data sheet contains information specific to batteries manufactured at the time of its publication.

Contents herein do not constitute a warranty.

© Energizer - All Rights Reserved